

PACUSB

USB Downstream Port Terminator

Product Description

The PACUSB-D1/D2 is a single-channel USB downstream-port termination network. It integrates EMI/RFI filter components R1 and C1, as recommended by the USB specification as well as the required 15 kW pull-down resistors (R2) to GND. In addition, PACUSB-D1/D2 provides a very high level of protection for sensitive electronic components that may be subjected to electrostatic discharge (ESD). The device pins will safely dissipate ESD strikes of ± 15 kV, exceeding the maximum requirements of the IEC 61000-4-2 international standard. Using the MIL-STD-883D (Method 3015) specification for Human Body Model (HBM) ESD, all pins are protected from contact discharges to ± 20 kV.

There are three options for the value of the series resistor R1: 15 Ω , 22 Ω , and 33 Ω . This series resistance, plus the USB driver output resistance, must be close to the USB cable's characteristic impedance of 45 Ω (each side) to minimize transmission line reflections.

The PACUSB-D1/D2 is manufactured in a 5-pin SC70 or a 5-pin SOT23 package and is available with optional lead-free finishing.

Features

- A Low-Capacitance USB Downstream Port Terminator, EMI Filter, and Transient Over-Voltage (ESD) Protector in a Single Surface-Mounted Package
- ESD Protection to ± 20 kV Contact Discharge, per MIL-STD-883D, Method 3015
- ESD Protection to ± 15 kV Contact Discharge, per IEC 61000-4-2 International Standard
- Compact SOT23-5 and SC70-5 Package Options Save Board Space and Lower Manufacturing Costs Compared to Discrete Solutions
- Capacitors Matched to a Precision Exceeding the USB Specification
- Pin-Compatible with ST Microelectronics USBDFxxW5 USB Downstream Port Terminator
- These Devices are Pb-Free and are RoHS Compliant

Applications

- ESD Protection and Termination of USB Downstream Ports
- Desktop PCs
- Notebooks
- Set-Top Boxes
- USB Hubs



ON Semiconductor®

<http://onsemi.com>

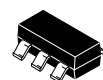

SOT23-5
CASE 527AH



SC70-5
CASE 419AC

ELECTRICAL SCHEMATIC

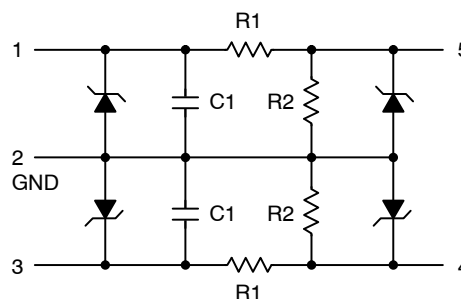

MARKING DIAGRAM

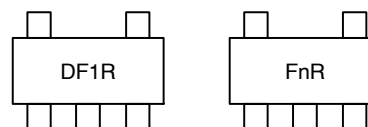

DF1R = PACUSB-D1Y5R
FnR = PACUSB-DnYB5R
n = 1, 2

ORDERING INFORMATION

Device	Package	Shipping†
PACUSB-D1Y5R	SOT23-5 (Pb-Free)	3000/Tape & Reel
PACUSB-D1YB5R	SC70-5 (Pb-Free)	3000/Tape & Reel
PACUSB-D2YB5R	SC70-5 (Pb-Free)	3000/Tape & Reel

†For information on tape and reel specifications, including part orientation and tape sizes, please refer to our Tape and Reel Packaging Specification Brochure, BRD8011/D.

PACUSB

PACKAGE / PINOUT DIAGRAMS

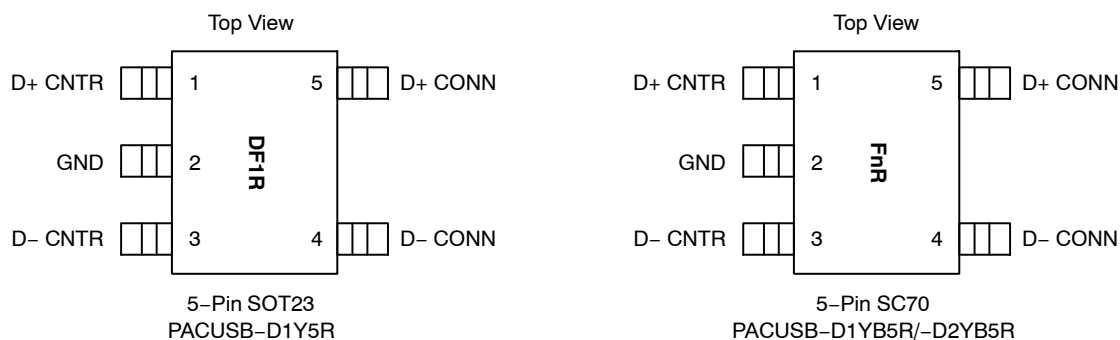

Note 1: The "n" shown in part markings above represents either the digit "1" or "2".
 Note 2: SOT23 and SC70 package sizes may differ. These drawing are not in scale.

Table 1. PIN DESCRIPTIONS

Pins	Name	Description
1	D+ CNTR	D+ Data to the USB Controller Circuitry
2	GND	Ground Pin
3	D- CNTR	D- Data to the USB Controller Circuitry
4	D- CONN	D- Data to the USB Connector
5	D+ CONN	D+ Data to the USB Connector

SPECIFICATIONS

Table 2. ABSOLUTE MAXIMUM RATINGS

Parameter	Rating	Units
Storage Temperature Range	-65 to +150	°C
Power Dissipation per Resistor	100	mW
Package Power Dissipation	200	mW
Voltage on any Pin (DC)	6	V

Stresses exceeding Maximum Ratings may damage the device. Maximum Ratings are stress ratings only. Functional operation above the Recommended Operating Conditions is not implied. Extended exposure to stresses above the Recommended Operating Conditions may affect device reliability.

Table 3. STANDARD OPERATING CONDITIONS

Parameter	Rating	Units
Operating Temperature	-40 to +85	°C

PACUSB

SPECIFICATIONS (Cont'd)

Table 4. ELECTRICAL OPERATING CHARACTERISTICS (Note 1)

Symbol	Parameter	Conditions	Min	Typ	Max	Units
R1	Resistance of R1 Resistor (PACUSB-D2YB5R)	$T_A = 25^\circ\text{C}$	12	15	18	Ω
R1	Resistance of R1 Resistor (PACUSB-D1Y5R, -D1YB5R)	$T_A = 25^\circ\text{C}$	26.4	33.0	39.6	Ω
R2	Resistance of R2 Resistor	$T_A = 25^\circ\text{C}$		15		k Ω
TCR	Temperature Coefficient of Resistance	(Note 1)		± 1300		ppm/ $^\circ\text{C}$
C1	Capacitance of C1 Capacitor	0 V DC, 30 mV AC, 1 MHz, 25°C	37.6	47.0	56.4	pF
		2.5 V DC, 30 mV AC, 1 MHz, 25°C	25.6	32.0	38.4	pF
TOL _{CM}	Matching Tolerance of C1 Capacitors	1 MHz, 25°C			± 2	%
I _{LEAK}	Diode Leakage Current to GND	Measured at 3.3 V DC, 25°C		1	100	nA
V _{RB}	Diode Reverse Bias Voltage	I _{LOAD} = 10 μA , $T_A = 25^\circ\text{C}$	5.5			V
V _{SIG}	Signal Voltage: Positive Clamp Negative Clamp	I _{LOAD} = 10 mA, $T_A = 25^\circ\text{C}$ I _{LOAD} = 10 mA, $T_A = 25^\circ\text{C}$	5.6 -0.4	6.8 -0.8	9.0 -1.5	V
V _{ESD}	In-system ESD Withstand Voltage MIL-STD-883D, Method 3015 (HBM) IEC 61000-4-2 Contact Discharge	Pins 1, 3 (Notes 2 and 3) Pins 4, 5 (Note 2) Pins 4, 5 (Note 2)	± 4 ± 20 ± 15			kV
V _{CL}	Clamping Voltage under ESD Discharge	MIL-STD-883D, Method 3015 +8 kV (Note 4)		12		V
		MIL-STD-883D, Method 3015 -8 kV (Note 4)		-7		V

1. Electrical operating characteristics guaranteed over standard operating conditions unless specified otherwise.
2. ESD voltage applied to pins with respect to GND, one at a time; unused pins are left open.
3. Pins 1 and 3 are not connected to the USB port connector, and therefore are not exposed to external ESD hazards. Thus, they do not require the high ESD protection levels provided for pins 4 and 5.
4. ESD Clamping Voltage is measured at the opposite end of R1 from the pin to which the ESD discharge is applied (e.g., if ESD is applied to pin 6, then the clamping voltage is measured at pin 1).

PACUSBD

PERFORMANCE INFORMATION

Capacitance vs. Voltage

The C1 capacitance value as a function of DC voltage across it is presented in Figure 1. The curve is normalized to a capacitance of 1.0 capacitance units at 2.5 V DC.

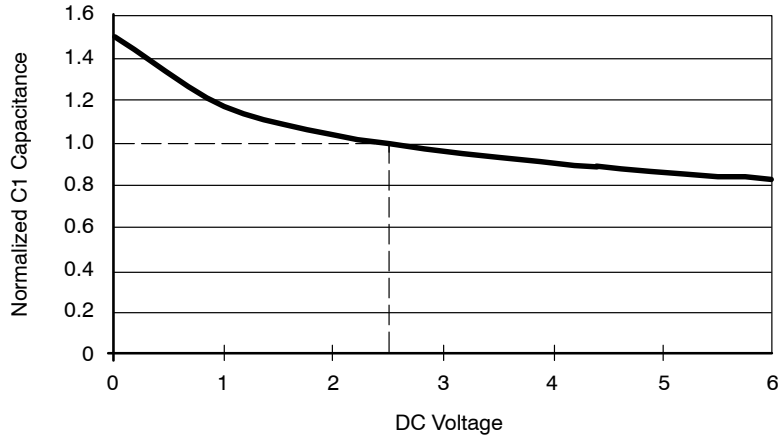

Figure 1. Diode Capacitance vs. DC Voltage (Normalized)

Insertion Loss vs. Frequency Characteristics

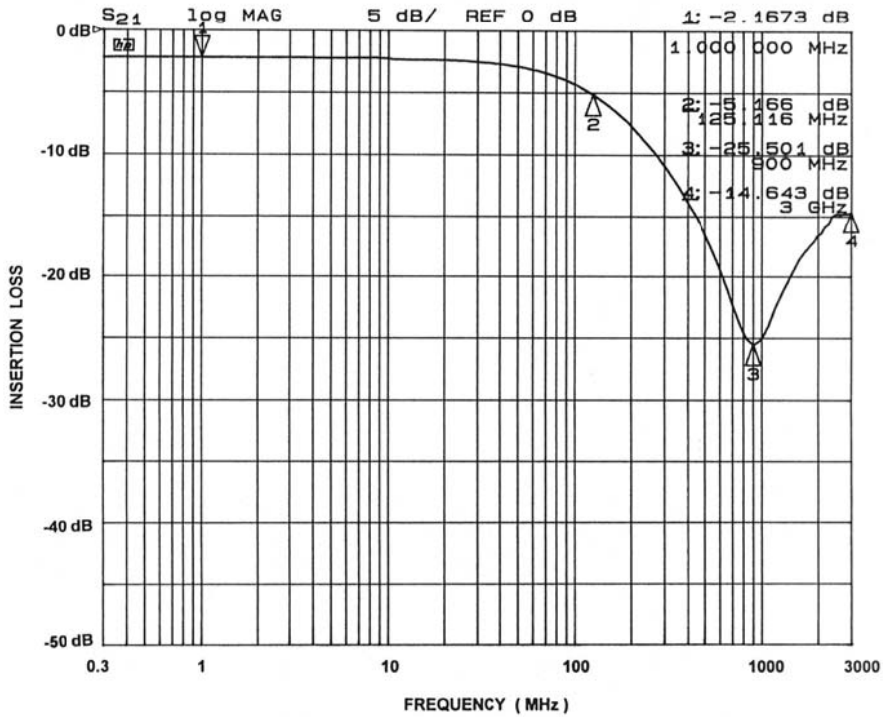

Figure 2. Insertion Loss vs. Frequency Performance Curve, PACUSB-D1 (SOT23-5)

PACUSB

PERFORMANCE INFORMATION (Cont'd)

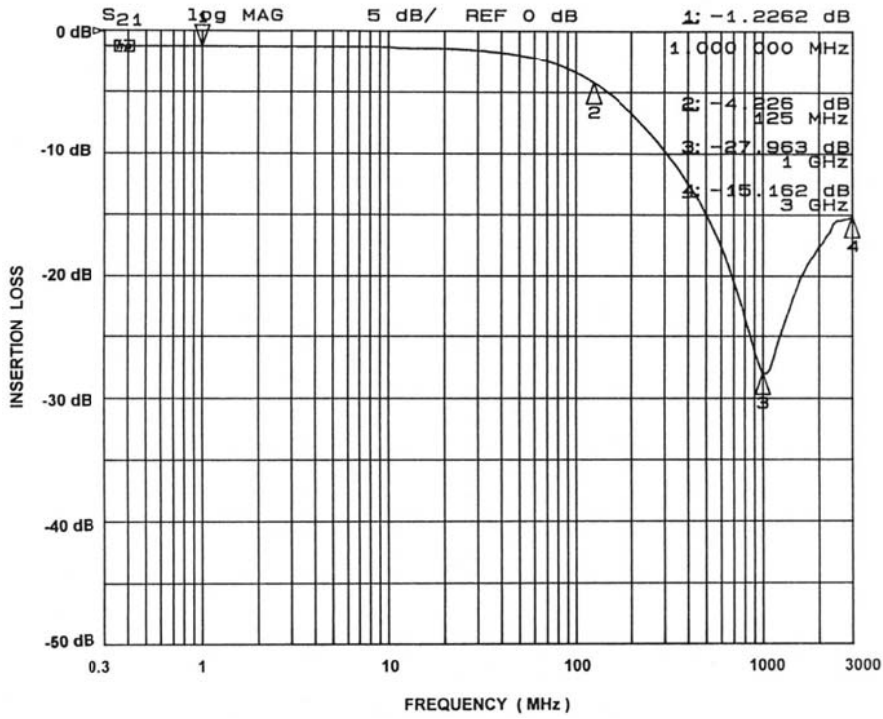

Figure 3. Insertion Loss vs. Frequency Performance Curve, PACUSB-D2 (SOT23-5)

PACUSB

APPLICATION INFORMATION

The PACUSB-D1/D2 provides a complete interface for a single downstream USB port typically found in computers and USB hubs. It integrates the series resistors (R1) and the 15 k Ω pull-down resistors (R2) for both USB data lines (D+ and D-) as well as the capacitors to ground for EMI suppression. Zener diodes provide ESD protection up to 15 kV contact discharge per the IEC 61000-4-2 standard and protect the USB controller on both data lines.

The PACUSB-D1/D2 should be placed on the PCB between the USB controller and the USB connector, as shown on the Connection Diagram, Figure 4.

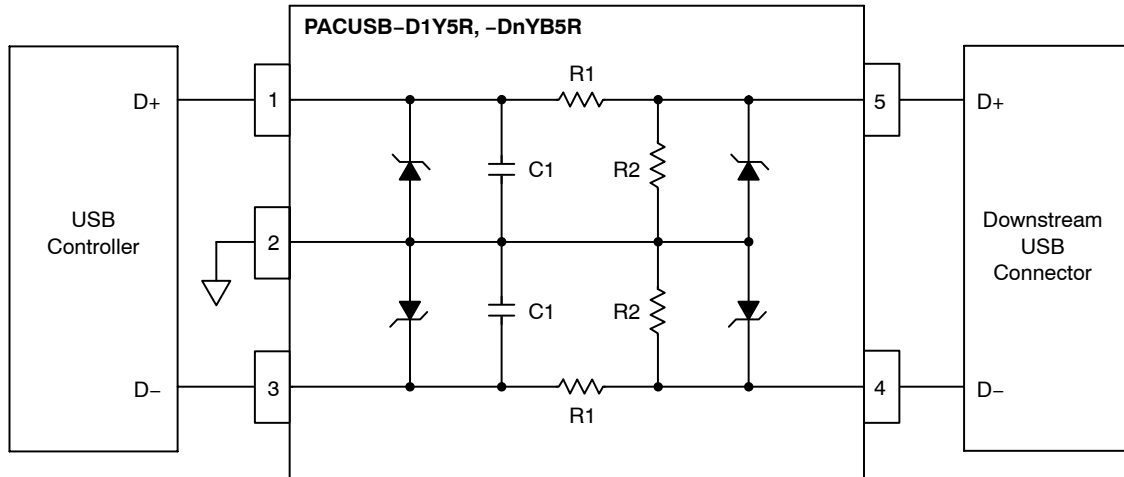

Figure 4. Connection Diagram for PACUSB-D1/D2 Devices

To guarantee the best ESD and filtering performance, it is recommended to physically locate the PACUSB-D1/D2 close to the USB connector. Also, the trace lengths between the PACUSB-D1/D2 and the USB controller should be kept as short as possible.

PACUSBD

PACKAGE DIMENSIONS

SOT-23, 5 Lead
CASE 527AH-01
ISSUE O

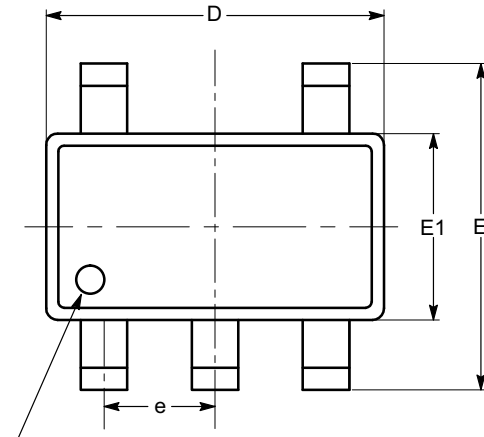

PIN #1 IDENTIFICATION

TOP VIEW

SYMBOL	MIN	NOM	MAX
A	0.90		1.45
A1	0.00		0.15
A2	0.90	1.15	1.30
b	0.30		0.50
c	0.08		0.22
D	2.90 BSC		
E	2.80 BSC		
E1	1.60 BSC		
e	0.95 BSC		
L	0.30	0.45	0.60
L1	0.60 REF		
L2	0.25 REF		
θ	0°	4°	8°
$\theta 1$	5°	10°	15°
$\theta 2$	5°	10°	15°

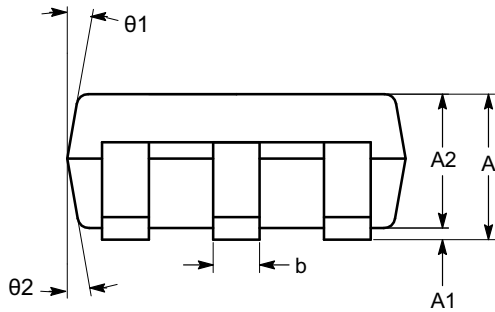

SIDE VIEW

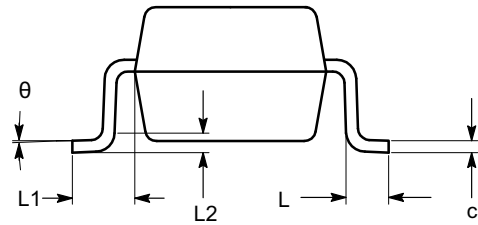

END VIEW

Notes:

- (1) All dimensions in millimeters. Angles in degrees.
- (2) Complies with JEDEC standard MO-178.

PACUSBD

PACKAGE DIMENSIONS

SC-88A (SC-70 5 Lead), 1.25x2
CASE 419AC-01
ISSUE A

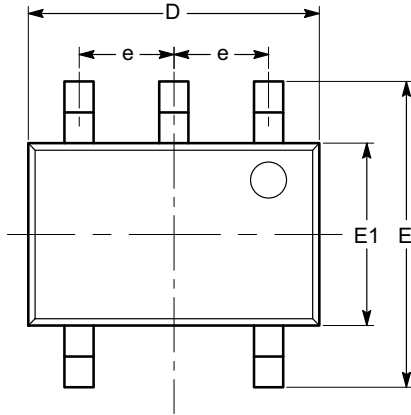

TOP VIEW

SYMBOL	MIN	NOM	MAX
A	0.80		1.10
A1	0.00		0.10
A2	0.80		1.00
b	0.15		0.30
c	0.10		0.18
D	1.80	2.00	2.20
E	1.80	2.10	2.40
E1	1.15	1.25	1.35
e	0.65 BSC		
L	0.26	0.36	0.46
L1	0.42 REF		
L2	0.15 BSC		
θ	0°		8°
θ_1	4°		10°

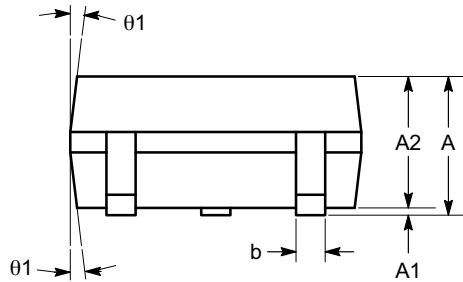

SIDE VIEW

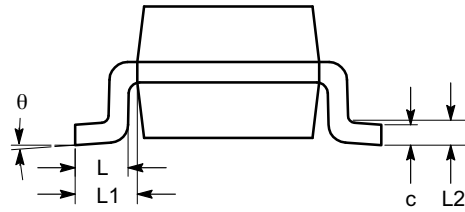

END VIEW

Notes:

- (1) All dimensions are in millimeters. Angles in degrees.
- (2) Complies with JEDEC MO-203.

ON Semiconductor and  are registered trademarks of Semiconductor Components Industries, LLC (SCILLC). SCILLC reserves the right to make changes without further notice to any products herein. SCILLC makes no warranty, representation or guarantee regarding the suitability of its products for any particular purpose, nor does SCILLC assume any liability arising out of the application or use of any product or circuit, and specifically disclaims any and all liability, including without limitation special, consequential or incidental damages. "Typical" parameters which may be provided in SCILLC data sheets and/or specifications can and do vary in different applications and actual performance may vary over time. All operating parameters, including "Typicals" must be validated for each customer application by customer's technical experts. SCILLC does not convey any license under its patent rights nor the rights of others. SCILLC products are not designed, intended, or authorized for use as components in systems intended for surgical implant into the body, or other applications intended to support or sustain life, or for any other application in which the failure of the SCILLC product could create a situation where personal injury or death may occur. Should Buyer purchase or use SCILLC products for any such unintended or unauthorized application, Buyer shall indemnify and hold SCILLC and its officers, employees, subsidiaries, affiliates, and distributors harmless against all claims, costs, damages, and expenses, and reasonable attorney fees arising out of, directly or indirectly, any claim of personal injury or death associated with such unintended or unauthorized use, even if such claim alleges that SCILLC was negligent regarding the design or manufacture of the part. SCILLC is an Equal Opportunity/Affirmative Action Employer. This literature is subject to all applicable copyright laws and is not for resale in any manner.

PUBLICATION ORDERING INFORMATION

LITERATURE FULFILLMENT:
Literature Distribution Center for ON Semiconductor
P.O. Box 5163, Denver, Colorado 80217 USA
Phone: 303-675-2175 or 800-344-3860 Toll Free USA/Canada
Fax: 303-675-2176 or 800-344-3867 Toll Free USA/Canada
Email: orderlit@onsemi.com

N. American Technical Support: 800-282-9855 Toll Free
USA/Canada
Europe, Middle East and Africa Technical Support:
Phone: 421 33 790 2910
Japan Customer Focus Center
Phone: 81-3-5817-1050

ON Semiconductor Website: www.onsemi.com
Order Literature: <http://www.onsemi.com/orderlit>
For additional information, please contact your local Sales Representative